

UROLOGY INSTRUMENTS



KIDNEY STONE FORCEPS

Nierensteinzangen

Pinces pour les calculs du bassin

Pinzas para cálculoa renales

Pinze per calcoli renali



Randall Kidney Stone Clamps Forceps

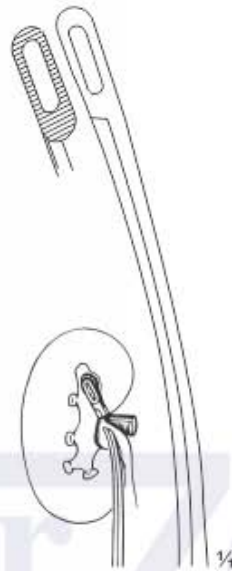

16-001
23 cm
quarter curved

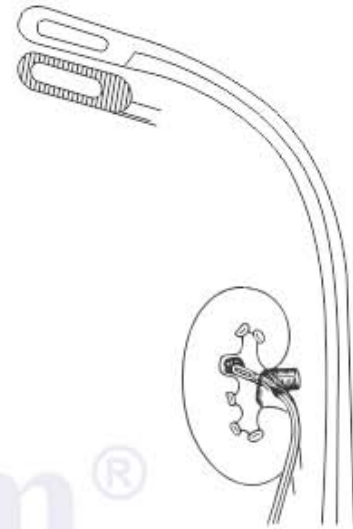

16-002
23 cm
half curved

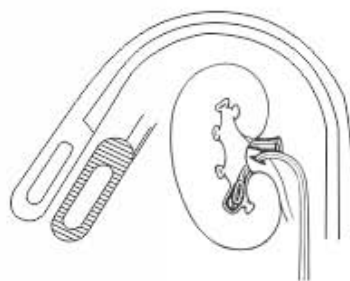

16-003
23 cm
full curved

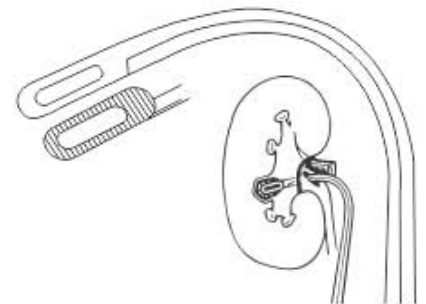

16-004
23 cm
three quarter curved

Nierensteinzangen

Pinces pour les calculs du bassinet

Pinzas para cálculoa renales

Pinze per calcoli renali



16-005
23 cm



16-006
24.5 cm



Randall
Kidney Stone Forceps



Heiming
Kidney Stone Forceps



16-007
16 cm



16-008
17 cm

B



Elsasser
Nephrostomy Forceps



16-009
21 cm
Fig. 1

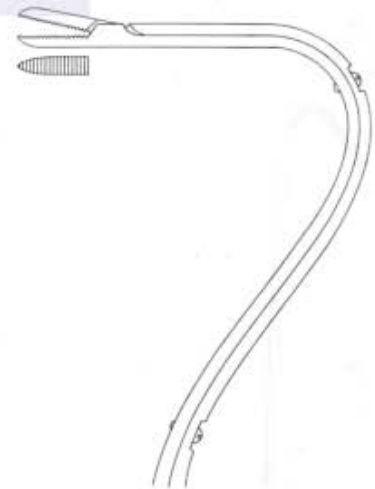

16-010
21 cm
Fig. 2

KIDNEY STONE FORCEPS

Nierensteinzangen	Pinces pour les calculs du bassin
Pinzas para cálculoa renales	Pinze per calcoli renali



Dartigues Uterine Elevating Forceps
16-011 27 cm



Collin Kidney Elevating Stone Clamps Forceps
16-012 28.5 cm



Hulka-Kenwick Uterine Elevating & Manipulating Forceps
16-013 27 cm



Somer Kidney Elevating Stone Clamps Forceps
16-014 23.5 cm



Strassmann Kidney Elevating Stone Clamps Forceps
16-015 26 cm



Collin Kidney Elevating Stone Clamps Forceps
16-016 26.5 cm

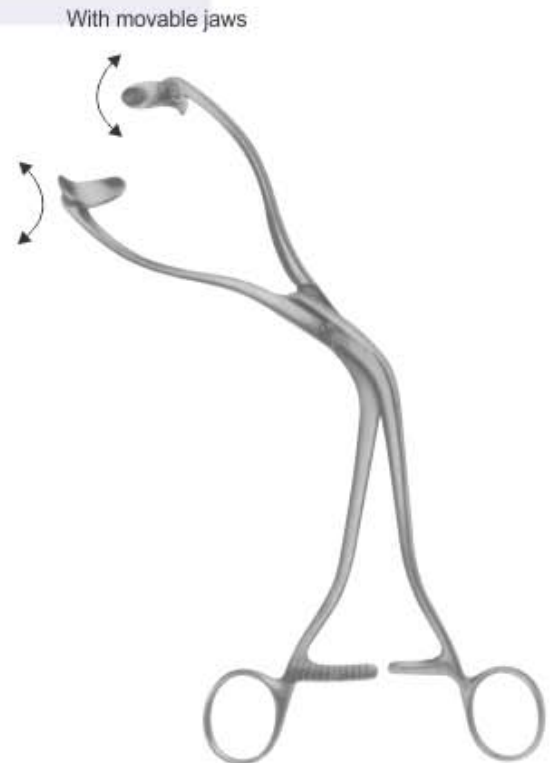

Collin Kidney Elevating Stone Clamps Forceps
16-017 26 cm



Blake Gall Stone Forceps
16-018 20 cm
Straight



Blake Gall Stone Forceps
16-019 21 cm
Curved



Mayo-Blake Gall Stone Forceps
16-020 20 cm
Straight



Mayo-Blake Gall Stone Forceps
16-021 20 cm
Curved

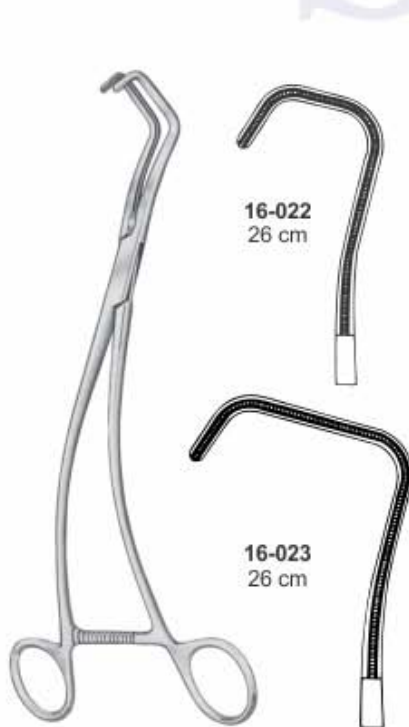

Uro-Tangential Gall Stone Forceps



Mixer Gall Stone Forceps
16-024 22 cm



Desjardins Gall Stone Forceps
16-025 23 cm



Desjardins Gall Stone Forceps
16-026 23 cm

CAPSULE FORCEPS, LIGATURE CARRYING FORCEPS

Kapselasszangen, Fadenführungszange | *Pinces pour saisir les capsules, Pince porte-fil*
Pinzas capsulares, Pinza porta ligaduras | *Pinze per afferrare capsule, Pinza porta-filo*

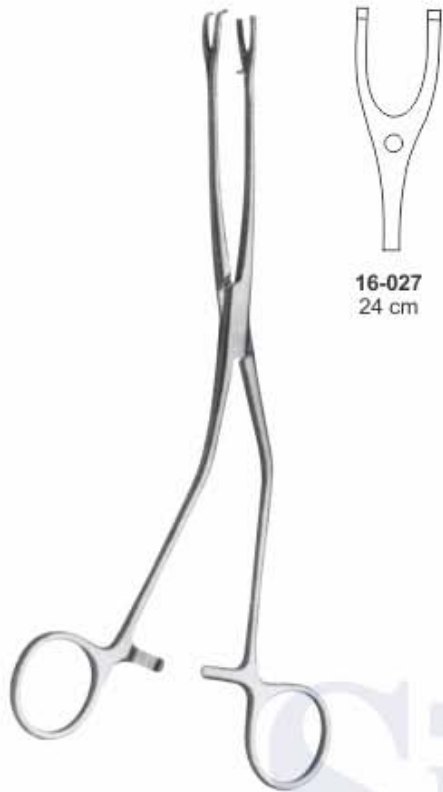

16-027
24 cm

Harris Capsule Ligature Angled Suture Forceps



16-028
29 cm

Johnson Prostatic Needle Holder



16-029
23 cm

Stratte Needle Holder



Millin Prostatectomy Forceps
16-030 24 cm



Millin Prostatectomy Forceps
16-031 23 cm



Millin Vulsellum Forceps
16-032 23 cm



Millin Ligature Carrying Forceps Angular
16-033 23 cm

Prostatahaken

Ecarteurs prostatiques

Separadores para próstata

Divaricatori prostatici

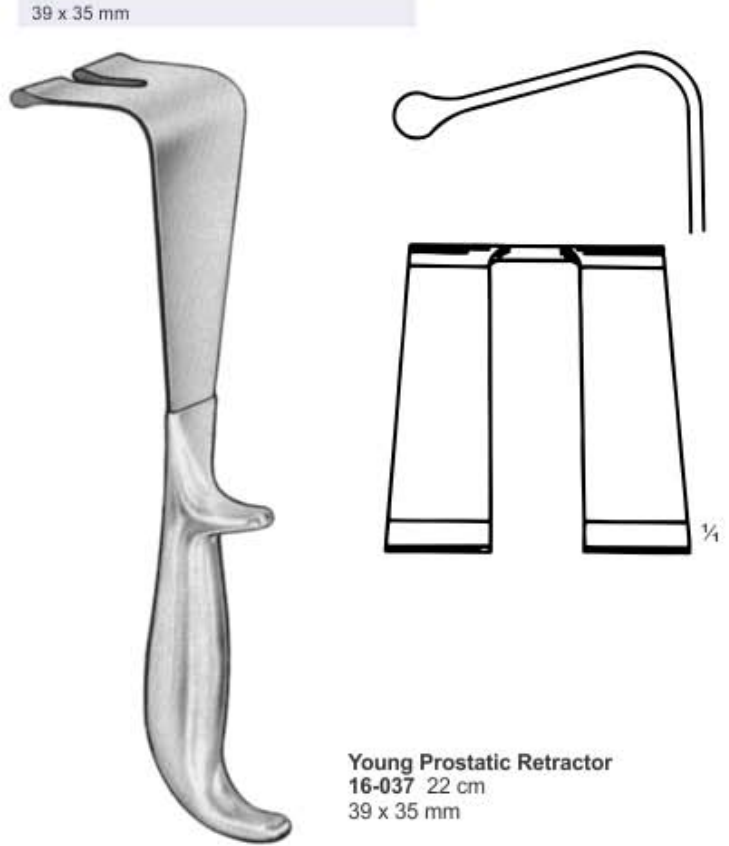
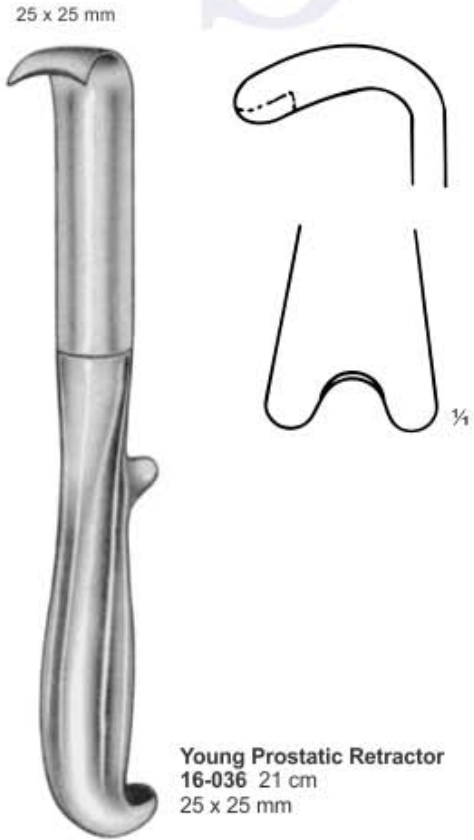
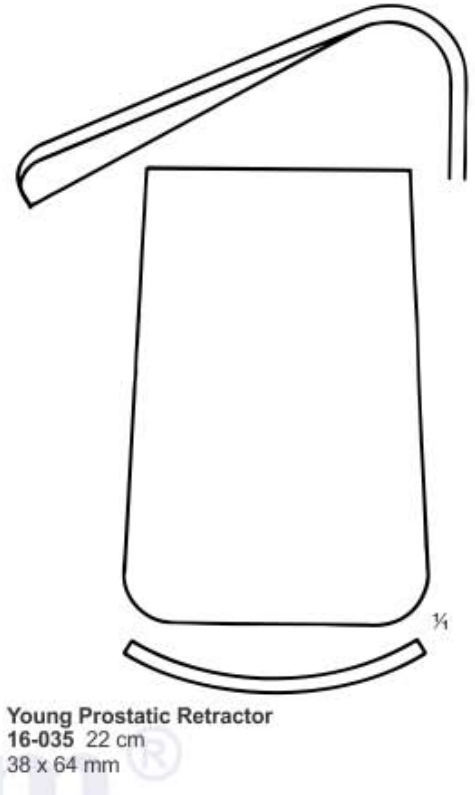
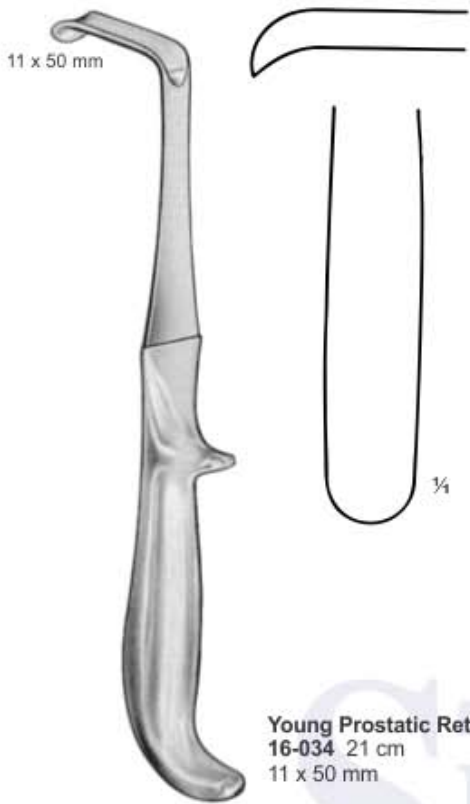

Gallenkanaldilatatoren | Dilatateurs pour les voies biliaires
 Gallensteinzangen | Pincettes pour calculs biliaires



**Desjardins Probe
& Catch with flexible
shaft 28 cm**



**16-038
17 F.G.**



**16-039
21 F.G.**



**16-040
24 F.G.**



**16-041
27 F.G.**



**Moynihan
16-042
34 cm**



**Bakes Common Bile
Duct Dilators, Malleable
16-043
Set of 13
32 cm**



**Fig. 1
16-044**



**Fig. 4
16-047**



**Fig. 7
16-050**



**Fig. 10
16-053**



**Fig. 2
16-045**



**Fig. 5
16-048**



**Fig. 8
16-051**



**Fig. 11
16-054**



**Fig. 3
16-046**



**Fig. 6
16-049**



**Fig. 9
16-052**



**Fig. 12
16-055**



**Fig. 13
16-056**



**Luer-Koerte
Modif With
Malleable Shaft
16-057
31 cm**



**16-058
2.8mm
Fig. 000**



**16-059
3.4mm
Fig. 00**



**16-060
4.3mm
Fig. 0**



**16-061
5.5mm
Fig. 1**



**16-062
6.7mm
Fig. 0**



**16-063
8.0mm
Fig. 3**



**16-064
11mm
Fig. 4**



**16-065
15mm
Fig. 5**



Catheter
16-066
15 cm
No. 6-16



Catheters 29 cm
Male Catheters charr., Metal

- French
- 16-067 8
 - 16-068 10
 - 16-069 12
 - 16-070 14
 - 16-071 16
 - 16-072 18
 - 16-073 20



Lister Bougies
16-074
27 cm
00 / 1 to 15 / 18
set of 17



Clutton Bougies
16-075 27 cm
06 / 10 FG to 28 / 32
set of 12



Van Buren
Urethral Sound
16-076
A to O
Set of 15

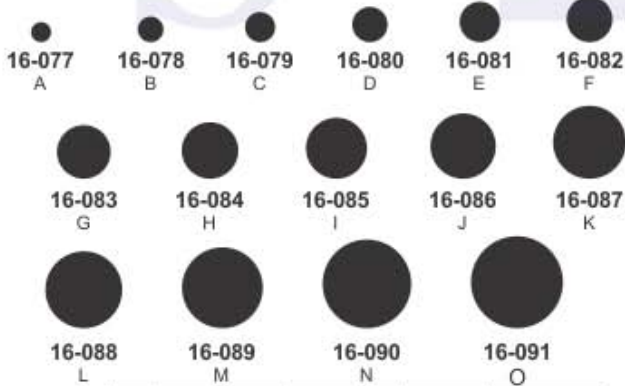
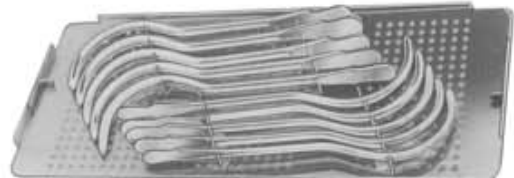
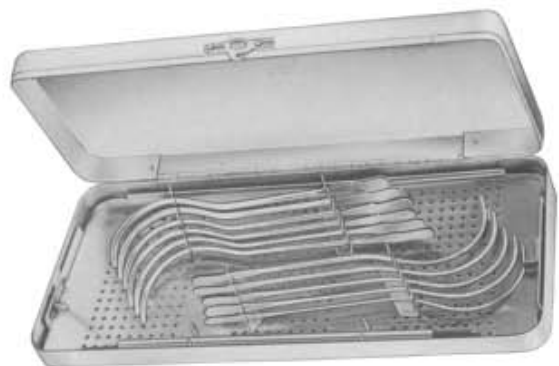

Fig.	Item	Description	Inches	Dia. Charr
A	16-077	28 cm	11"	8 French
B	16-078	28 cm	11"	10 French
C	16-079	28 cm	11"	12 French
D	16-080	28 cm	11"	14 French
E	16-081	28 cm	11"	16 French
F	16-082	28 cm	11"	18 French
G	16-083	28 cm	11"	20 French
H	16-084	28 cm	11"	22 French
I	16-085	28 cm	11"	24 French
J	16-086	28 cm	11"	26 French
K	16-087	28 cm	11"	28 French
L	16-088	28 cm	11"	30 French
M	16-089	28 cm	11"	32 French
N	16-090	28 cm	11"	34 French
O	16-091	28 cm	11"	36 French



Guyon
16-092
420 x 175 x 40 mm
Set in metal case containing:
— 21 Bougies Guyon
— 6 filiform Bougies

Urethalkatheter | Cateteri Uretrali
 Sondes Urétrales | Catéteres Uretrales



Dittel
 22.5 cm
 urethral bougies and
 dilating sounds

	Charr. (French)
16-093	8
16-094	9
16-095	10
16-096	11
16-097	12
16-098	13
16-099	14
16-100	15
16-101	16
16-102	17
16-103	18
16-104	19
16-105	20
16-106	21
16-107	22
16-108	23
16-109	24
16-110	25
16-111	26
16-112	27
16-113	28
16-114	29
16-115	30



Dittel
 35 cm
 urethral bougies and
 dilating sounds

	Charr. (French)
16-116	8
16-117	9
16-118	10
16-119	11
16-120	12
16-121	13
16-122	14
16-123	15
16-124	16
16-125	17
16-126	18
16-127	19
16-128	20
16-129	21
16-130	22
16-131	23
16-132	24
16-133	25
16-134	26
16-135	27
16-136	28
16-137	29
16-138	30



33 cm
 filiform guides,
 olive tip

	Charr. (French)
16-139	3
16-140	4
16-141	5
16-142	6



Guyon
16-143
 25 cm
 Set
 urethral bougies and
 dilating sounds
 without filiform guides,
 with thread in tip

	Charr. (French)
16-144	Ben. 24 / Charr. 12 Ben. 25
16-145	Ben. 26 / Charr. 13 Ben. 27
16-146	Ben. 28 / Charr. 14 Ben. 29
16-147	Ben. 30 / Charr. 15 Ben. 31
16-148	Ben. 32 / Charr. 16 Ben. 33
16-149	Ben. 34 / Charr. 17 Ben. 35
16-150	Ben. 36 / Charr. 18 Ben. 37
16-151	Ben. 38 / Charr. 19 Ben. 39
16-152	Ben. 40 / Charr. 20 Ben. 41
16-153	Ben. 42 / Charr. 21 Ben. 43
16-154	Ben. 44 / Charr. 22 Ben. 45
16-155	Ben. 46 / Charr. 23 Ben. 47
16-156	Ben. 48 / Charr. 24 Ben. 49
16-157	Ben. 50 / Charr. 25 Ben. 51
16-158	Ben. 52 / Charr. 26 Ben. 53
16-159	Ben. 54 / Charr. 27 Ben. 55
16-160	Ben. 56 / Charr. 28 Ben. 57
16-161	Ben. 58 / Charr. 29 Ben. 59
16-162	Ben. 60 / Charr. 30

Blasenhalsperrer, Blasenwundsperrer

Ecarteur pour le col de la vessie, Ecarteurs vésicaux

Dilatador para el cuello vesical, Separadores vesicales

Divaricatore del collo vescicale, Divaricatore vescicale



Knutson
16-163 18 cm
Urethrographie-Instruments



Mogen Circumcision Clamp
16-165



Circumcision Shield
16-166 10cm



Winkelmann Circumcision Clamps
16-167 12 mm Ø
16-168 16 mm Ø
16-169 20 mm Ø

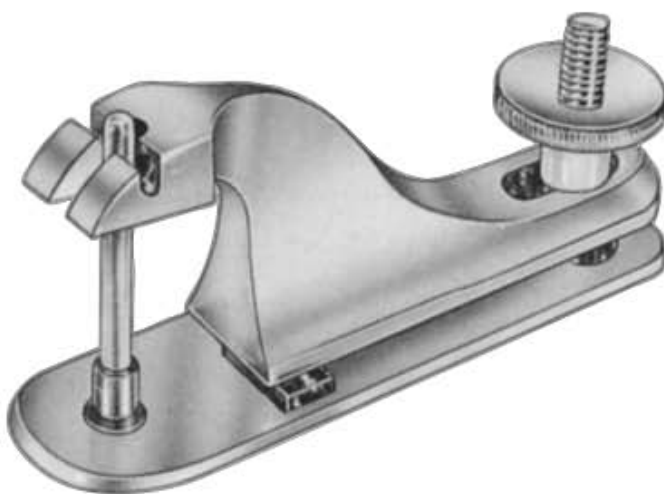

Gumco Circumcision Clamp
mm Ø
16-170 8
16-171 11
16-172 13
16-173 16
16-174 21
16-175 26
16-176 32



Stockmann Penile Clamp
16-177 8cm

BLADDER NECK SPREADER, BLADDER RETRACTORS

Blasenhalsperrer, Blasenwundsperrer

Ecarteur pour le col de la vessie, Ecarteurs vésicaux

Dilatador para el cuello vesical, Separadores vesicales

Divaricatore del collo vescicale, Divaricatore vescicale



Millin Bladder Neck Spreader
16-178
28 cm



Zieser Meaeus Clamp
16-179 10cm



Strauss Penile Clamp
16-180 11cm



Thomson Walker Penile Clamp
16-181



Lewkowitz Lithotomy Forceps
16-182 26cm Str.



Lewkowitz Lithotomy Forceps
16-183 26cm Cvd



Young Lobe Holding Forceps
16-184 20cm

Blasenhalsperrer, Blasenwundsperrer

Ecarteur pour le col de la vessie, Ecarteurs vésicaux

Dilatador para el cuello vesical, Separadores vesicales

Divaricatore del collo vescicale, Divaricatore vescicale



Legueu Bladder Spatula
16-185



Gosset Bladder Retractor
16-186 160mm



Thomson Walker Bladder Retractor
16-187

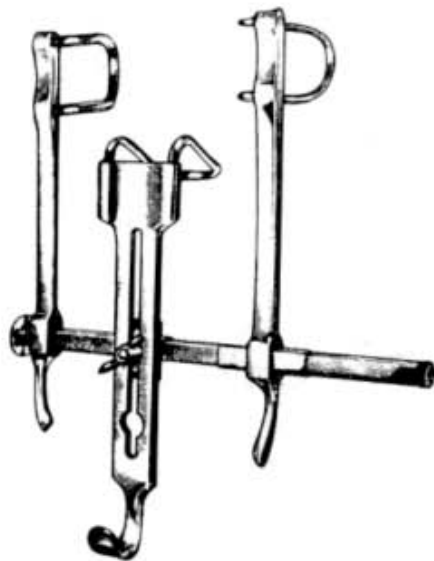

Pantings Bladder Retractor
16-188



Judd Masson Bladder Retractor
16-189
w/center blade



Millin Bladder Retractor
16-190

Leistenbruch Director, Vasektomie Zange, Schraubstock & Blase Retractor
Directora Hernia, Pinzas vasectomia, abrazadera y la vejiga retractor

Directeur de hernie, Pincas de vasectomie, Clamp et la vessie enrrouleur
Direttore Ernia, Pinze vasectomia, Clamp & vescica Divaricatore



Child Hernia Director
16-191



Key Hernia Director
16-192



Teale Hernia Director
16-193



Millin Suction Tube
16-194



Cord Hook
16-195
blunt 16cm



Gutmann Secretions Scoop
16-196 26cm



No Scalpel Vasectomy Ringed Forceps Clamps
16-197 14cm



No Scalpel Vasectomy Hemostat Forceps
16-198 14cm
smooth sharp point curved



Legueu Bladder Retractor
16-199
27cm



Kocher's Bladder Retractor
16-200 23.5 cm

RECTUM VASECTOMY SET OF 4 PCS
16-201



RECTUM VASECTOMY SET OF 4 PCS
16-202



RECTUM VASECTOMY SET OF 2 PCS
16-203



RECTUM VASECTOMY SET OF 3 PCS
16-204



RECTUM VASECTOMY SET OF 4 PCS
16-205